



# **SPARE PARTS ECOMMERCE**

Guida Utenti - clienti Ducale

3 marzo 2021 - Milano

# 01

---

## Indice

- I. Accesso a E-commerce Evoca
- II. Navigazione Web
- III. Utente: inserimento ordini

# Accesso E-commerce Evoca

Per accedere all' e-Commerce Evoca è necessario collegarsi all'area riservata del sito istituzionale <https://reservedarea.evocagroup.com/> o fare login direttamente dall' e-Commerce stessa <https://ecommerce.evocagroup.com.>

**EVOCA**  
G R O U P

RESERVED AREA

?

GO TO EVOCA WEBSITE

**Welcome to the Evoca reserved area.**

The reserved area provides a number of extra features and information available to Evoca Group's customers to assist them in dealing with service related information.

**SPARE PARTS ECOMMERCE**  
Marketplace to purchase Evoca original spare parts at a competitive price.

SIGN UP WITH EVOCA ID

**PAYMENT SYSTEM AND GLOBAL MANAGEMENT SYSTEM**  
Enter this area to download softwares, documentation and instructions.

SIGN UP WITH EVOCA ID

SIGN UP WITH EVOCA ID

Viene richiesto di inserire le proprie credenziali (indirizzo email di registrazione e password).  
In caso di nuovo utente si può chiedere l'accesso compilando il form di richiesta di accesso.

# Accesso E-commerce Evoca

RICHIESTA DI NUOVO ACCESSO PER BRAND DUCALE – deve essere un nuovo accesso rispetto a quello che si ha per i brands Necta, Saeco, Gaggia e Wittenborg



## SIGN IN

**Warning:** starting January 28th, you will no longer be able to use your username.  
Please use the registration e-mail address.

Email address\*

Password\* [Forgot Password?](#)

→ LOG IN

### Don't have an Evoca ID?

The **EVOKA ID** allows you access to the fully interactive spare parts ecommerce and newis catalogue, and offering free downloads of technical and marketing documentation.

Moreover, you will be able to access the Investors site.

[CREATE ONE NOW](#)

# Accesso E-commerce Evoca

## 1/2 GENERAL INFORMATIONS

First name\*

Mario

Last name\*

Rossi

Email address\*

mario.rossi@yahoo.it

I agree to the EVOCA Terms of Service and Privacy Policy.\*

→ NEXT STEP

# Accesso E-commerce Evoca

E' importante indicare che si è clienti della società Ducale Srl

## 2/2 ADDITIONAL INFORMATIONS

Company\*

MARIO ROSSI SPA

Country\*

Italy

Street address\*

VIA ROMA 24

Postal code

24030

City\*

VALBREMBO

Province\*

Bergamo

Phone

035606111

Evoca Group representative / Agency

Ducale Srl

I agree to the [EVOCA Terms of Service and Privacy Policy](#).\*

I'm not a robot



# Navigazione web

Con il nuovo accesso si potrà solo accedere al brand Ducale

NAVIGA PER BRAND



# Navigazione web



Ricerca | I miei ordini

HOME / DUCALE / COFFEE VENDING MACHINES

## Gamma prodotti

Ordina Per

HOME / DUCALE

## Gamma prodotti



COFFEE VENDING MACHINES



City 300



City 750



City Blindata



Starbar



City 500 - 500 Star



City 600 - 600 Star



City 700 - 700 Star



# Navigazione web

Per ogni Catalogo saranno presenti diverse tavole



Ricerca | I miei ordini

♡ ☆ 🛒

HOME / DUCALE / COFFEE VENDING MACHINES / CITY 750 / CITY 750 - 230V 50HZ

## City 750 - 230V 50HZ

☆ AGGIUNGI AI PREFERITI
↓ SCARICA L'ESPLOSO



Macinadosatore caffè (parte esterna) -  
1



Macinadosatore caffè (parte interna) -  
2

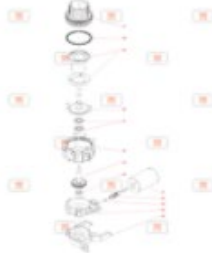

Macinadosatore caffè (macinino) - 3

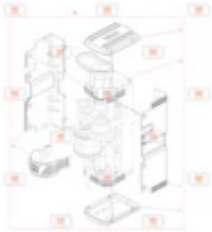

Gruppo caffè (parte esterna) - 4

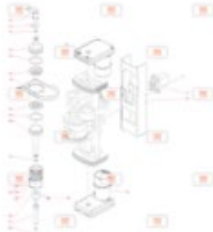

Gruppo caffè (parte interna) - 5



Gruppo caffè (camera infusione) - 6

## Utente - Inserimento ordine.

Gli ordini possono essere inseriti nei seguenti modi

- 1) selezione del codice nella tavola
- 2) funzione Ricerca quando si conosce il codice
- 3) attraverso il caricamento di un file di excell

# Utente - Inserimento ordine: selezione del codice nella tavola

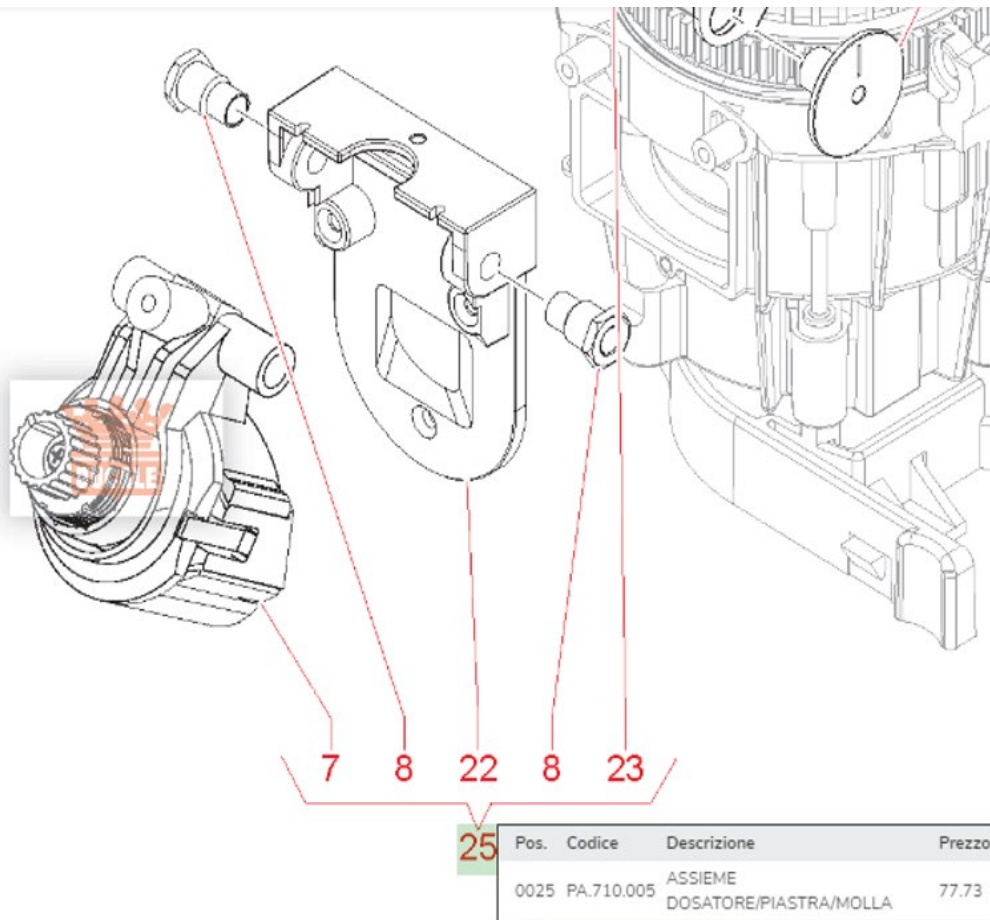

image not available



PA.710.005

ASSIEME DOSATORE/PIASTRA/MOLLA

Quantità

Listino netto 77,73 EUR

Disponibilità

Specificare la data

Note

Eventuali sconti aggiuntivi saranno visualizzati nel carrello

[Aggiungi a Wishlist](#)

# Utente - Inserimento ordine: funzione Ricerca

 Ricerca I miei ordini ♥ ☆ 🛒

**Ricerca**

Pezzo di ricambio Prodotti Documenti

Marchio  Descrizione

Solo Ricambi con Foto  Mostra solo ricambi ordinabili  Solo pezzi in promozione

**CERCA** AZZERA

Esito ricerca: 1 voci **STAMPA SU FILE**

Vedi	Foto	Codice	Sost. Da	Descrizione	Listino EUR
		PA.710.005		ASSIEME DOSATORE/PIASTRA/MOLLA	77,73

Esito ricerca: 1 voci



image  
not available



PA.710.005  
ASSIEME DOSATORE/PIASTRA/MOLLA

Quantità

Listino netto 77,73 EUR

Disponibilità ●

Specificare la data

Note

Eventuali sconti aggiuntivi saranno visualizzati nel carrello

[♥ Aggiungi a Wishlist](#)

# Utente - Inserimento ordine: Caricamento file

Il cliente può inserire l'ordine digitando direttamente i codici nel carrello o importando un file excel con indicato il codice ricambio e la quantità che desidera ordinare.

Benvenuto  
Ultimo Test

Ordine ricambi - Codice:

1 Carrello 2 Ordine 3 Riepilogo

Aggiungi all'ordine

Codice 1 Note Aggiungi Importa da file

In questo momento non sono presenti prodotti nel tuo carrello  
 Aggiungere un prodotto nel carrello non ti vincola all'acquisto. Dalla pagina del tuo carrello è infatti possibile variare le quantità dei prodotti selezionati, togliere alcuni prodotti e vedere l'effettivo ammontare del tuo eventuale acquisto.

## Opzioni d'importazione

- Sostituire l'ordine completamente
- Aggiungere all'ordine corrente
- Incrementa la quantità in caso di codici ripetuti

## Selezionare il file da importare

Scegli file Nessun file selezionato

Il file deve essere in formato *xlsx*

Composto da due sole colonne: Codice , Quantità

Le prima riga non viene considerata

Importa

Chiudi

formato file: *xlsx*

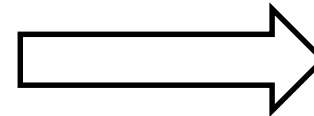







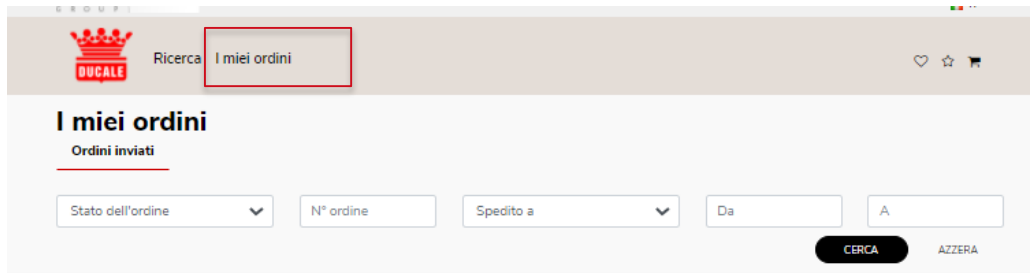

	A	B
1	item	qty
2	090957	1
3	09102520	2
4	09109005	3
5	091116	4
6	091159	5
7	09116010	6
8	09116025	7
9	091192	8
10	09122010	9
11	09124306	10

# Utente inserimento ordine

In ogni momento il cliente puo' verificare lo stato del suo ordine



Esito ricerca: 13 voci

Apri	Data	N° ordine	Ordine di vendita	Ragione sociale	Status	Totale Pezzi	Totale Netto	Valuta	Note	Elimina
	22/02/2021	21-00013		AUTOMATIC SERVICE S.r.l.		1	58,45	EUR		
	02/02/2021	21-00012		AUTOMATIC SERVICE S.r.l.		1	448,00	EUR		
	02/02/2021	TEST TOPGRAF 6		AUTOMATIC SERVICE S.r.l.		2	465,39	EUR	TEST TOPGRAF 6	
	02/02/2021	TEST TOPGRAF 5		AUTOMATIC SERVICE S.r.l.		2	465,39	EUR	TEST TOPGRAF 5	

Stato



Ordine inviato con successo



Invio ordine in corso

Apri





**Grazie.**

[www.evocagroup.com](http://www.evocagroup.com)